

# 50.2

FOR FASTENING SHEET TO PURLINS OF 1.2MM-3.5MM THICKNESS

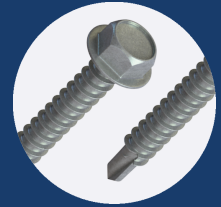

## PROPERTIES

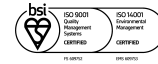

MATERIAL	CARBON STEEL
COATING	500 HRS (SILVER)
HEAD TYPE	HEX
DRILL POINT	2 PT
EFFECTIVE THREAD LENGTH	41.00
RECOMMENDED DRILL BIT/SOCKET	SOCKET-HEX-5/16" MAG
RECOMMENDED DRILL SPEED	1500 - 2500 RPM

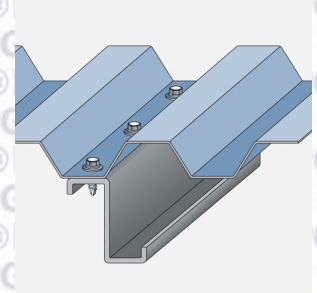

## PERFORMANCE

### PULL OUT

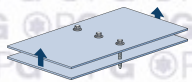

STEEL THICKNESS (MM)	1.20	1.60	2.00	2.50	3.00
VALUE (kN)	2.44	3.82	5.62	7.26	7.10

Grade of material: S450 Steel

### PULL OVER



WASHER	16MM x 2MM		19MM x 2MM	
SHEET THICKNESS (MM)	0.50	0.70	0.50	0.70
VALUE (kN)	3.92	5.61	4.01	5.80

### SHEAR

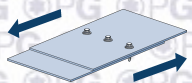

VALUE (kN)	7.30
------------	------

### TENSILE

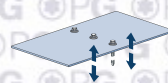

VALUE (kN)	14.10
------------	-------

## DIMENSIONS

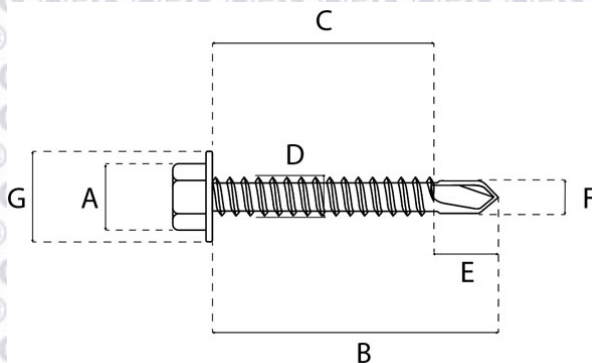

A (MM)	8.64
B (MM)	50.00
C (MM)	44.00
D (MM)	5.50
E (MM)	7.00
F (MM)	4.52
G (MM)	12.25