

80.2SS

FOR FASTENING SHEET TO PURLINS OF 1.2MM-3.5MM THICKNESS

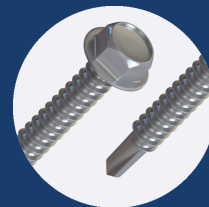

PROPERTIES



MATERIAL	STAINLESS STEEL A2 - 304 GRADE
COATING	500 HRS (SILVER)
HEAD TYPE	HEX
DRILL POINT	2 PT
EFFECTIVE THREAD LENGTH	44.1
RECOMMENDED DRILL BIT/SOCKET	SOCKET-HEX-5/16"RING
RECOMMENDED DRILL SPEED	1500 - 2500 RPM

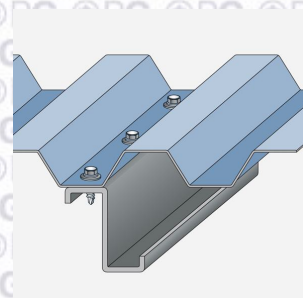

PERFORMANCE

PULL OUT

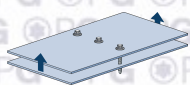

STEEL THICKNESS (MM)	1.20	1.60	2.00	2.50	3.00
VALUE (kN)	2.56	3.78	5.06	7.24	7.36

Grade of material: S450 Steel

PULL OVER

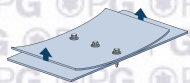

WASHER	16MM x 2MM		19MM x 2MM	
SHEET THICKNESS (MM)	0.50	0.70	0.50	0.70
VALUE (kN)	3.73	5.76	4.27	5.92

SHEAR

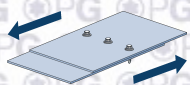

VALUE (kN)	8.56
------------	------

TENSILE

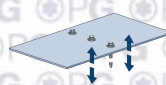

VALUE (kN)	8.78
------------	------

DIMENSIONS

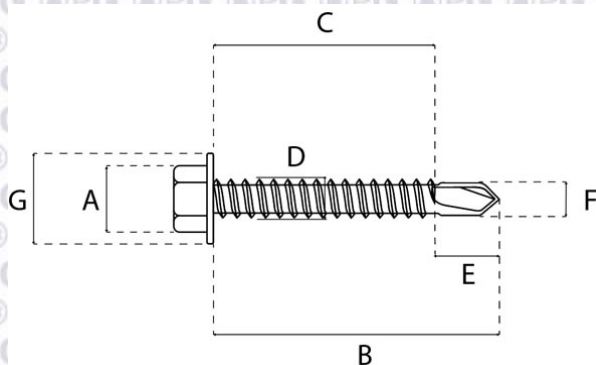

A (MM)	8.64
B (MM)	80.00
C (MM)	74.75
D (MM)	5.50
E (MM)	6.00
F (MM)	4.47
G (MM)	12.25